

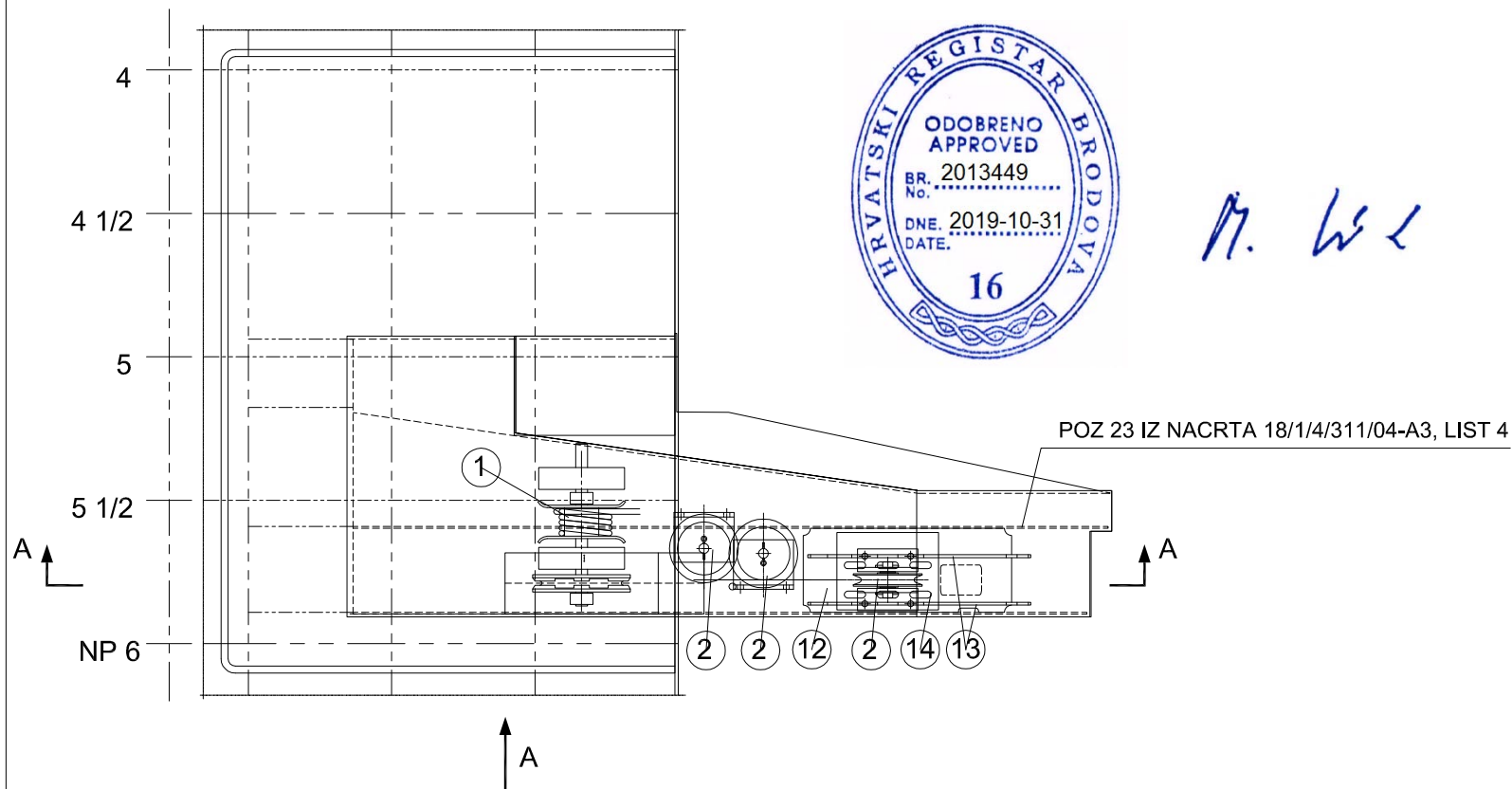

M. W L

GRADITELJ:									
<b>OBJEKT: SKELA KRIŽNICA</b>									
				Datum	Ime	Naziv nacrta:	Mjerilo:		
				Projektirao	02.05.2019 Lj. Čubrilo, dipl.ing.	KRMENI TORANJ RAMPE SMJEŠTAJ KOLA, SILE U UŽETIMA DIJELOVI PRIHVATA ZA TORANJ			
				Činac	02.05.2019 Lj. Čubrilo, dipl.ing.				
				Kontrolirao					
A	List 3/3 List 2/3	19.09.2019	Lj. Čubrilo, dipl.ing.	STIL d.o.o.		Broj nacrta:	18/1/3/311/05	List Broj: Od 1 3	Izdanje:
Index	Izmjene	Datum	Ime	FILOMAR d.o.o.		Broj projekta:	10067/18A	<del>A</del> B	

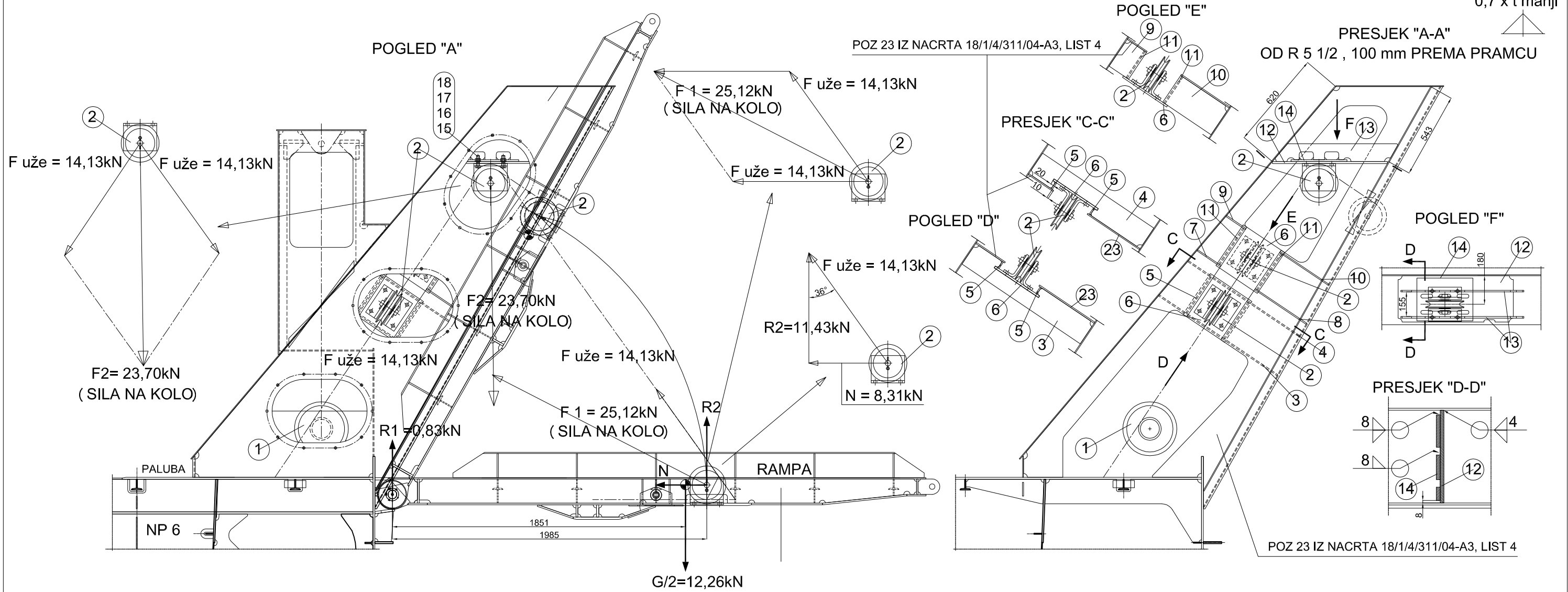

POZ	KOM	NAZIV	STANDARD	MATERIJAL	VELIČINA/MASA	NAPOMENA
18	24	ŠPLENTA	DIN 94	Č	4x50	
17	24	ELASTIČNA PODLOŠKA	DIN 127	Č	A 20	
16	24	MATICA	DIN 935	ČV 8	M 20	
15	24	VIJAK	DIN 931	ČV 8	M 20x80	PROBITI RUPU ZA POZ 22
14	2	PODEBLJANJE POZ.12		Č 0461	t=12mm	
13	4	UZDUŽNA UKREPA GORNJEG KOLA		Č 0461	t=10mm	
12	2	TEMELJNA PLOČA GORNJEG KOLA		Č 0461	t=12mm	
11	4	UZDUŽNA UKREPA SREDNJEG KOLA		Č 0461	t=8mm	
10	2	GORNJA UKREPA SREDNJEG KOLA		Č 0461	t=8mm	
9	2	GORNJA UKREPA SREDNJEG KOLA		Č 0461	t=8mm	
8	2	DONJA UKREPA SREDNJEG KOLA		Č 0461	t=8mm	
7	2	DONJA UKREPA SREDNJEG KOLA		Č 0461	t=8mm	
6	4	TEMELJNA PLOČA DONJEG I SREDNJEG KOLA		Č 0461	t=12mm	
5	4	UZDUŽNA UKREPA DONJEG KOLA		Č 0461	t=8mm	
4	2	GORNJA UKREPA DONJEG KOLA		Č 0461	t=8mm	
3	2	DONJA UKREPA DONJEG KOLA		Č 0461	t=8mm	
2		KOLO*				VIDI Nc.Br: 18/1/4/311/02-A4
1		VITLO				VIDI Nc.Br: 18/1/4/311/02-A4
POZ	KOM	NAZIV	STANDARD	MATERIJAL	VELIČINA/MASA	NAPOMENA
GRADITELJ:						

### OBJEKT: SKELA KRIŽNICA

Datum		Ime		Naziv nacrt:		Mjerilo:	
02.05.2019		Lj.Čubrilo, dipl.ing.		KRMENI TORANJ RAMPE		1:25	
02.05.2019		Lj.Čubrilo, dipl.ing.		SMJEŠTAJ KOLA, SILE U UŽETIMA		Izdanje:	
19.09.2019		Lj.Čubrilo, dipl.ing.		DIJELOVI PRIHVATA ZA TORANJ		A B	
STIL d.o.o.				Broj nacrt:		List	
FILOMAR d.o.o.				18/1/3/311/05-A3		Broj: Od	
Index				Izmjene		Datum	
Ime				Ime		Ime	
Broj projekta:				10067/18A			

\* - DOBAVLJAČ "LENGER" d.o.o.

3

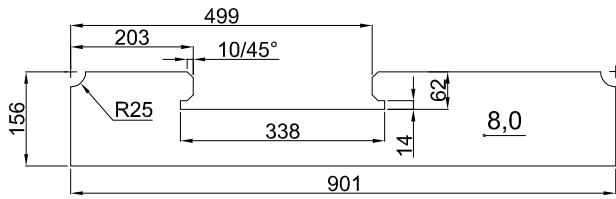

4

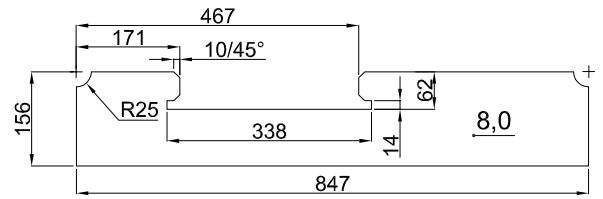

5

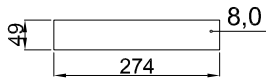

6

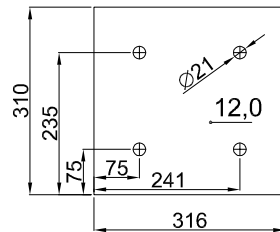

7

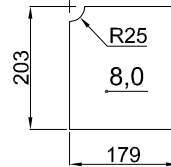

8

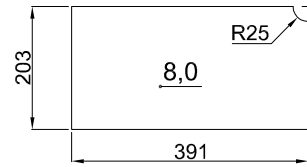

9

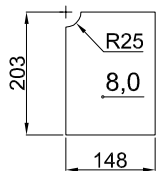

10

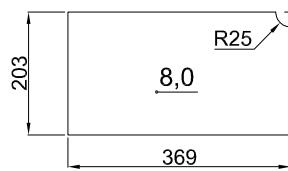

11

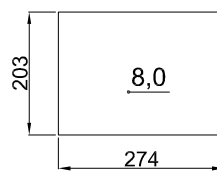

12

RUPE Ø21 BUŠTI NAKON ZAVARIVANJA POZ.24 NA POZ.12

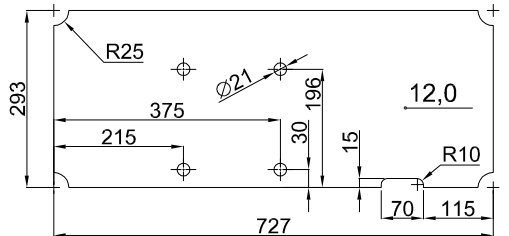

13

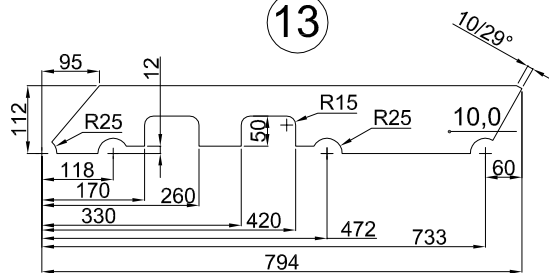

14

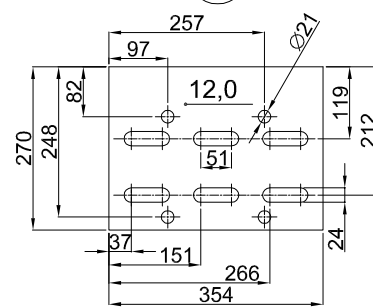

RUPE Ø21 BUŠTI NAKON ZAVARIVANJA POZ.24 NA POZ.12



M. W L

GRADITELJ:

OBJEKT: SKELA KRIŽNICA

		Datum		Ime		Naziv nacrt:		Mjerilo:	
		02.05.2019		Lj.Čubrilo,dipl.ing.		KRMENI TORANJ RAMPE		1:12,5	
		02.05.2019		Lj.Čubrilo,dipl.ing.		DIJELOVI PRIHVATA ZA KOLA			
A		Dodana Poz.17		19.09.2019		Lj.Čubrilo,dipl.ing.		Broj nacrt:	
		Dodana Poz.24						List	
		Izmjena Poz.13				STIL d.o.o.		Broj: 18/1/3/311/05-A4	
Index		Izmjene		Datum		Ime		Izdanje:	
						FILOMAR d.o.o.		3 / 3	
						Broj projekta:		A/B	
						10067/18A			